

MyMotion

# Technical Specifications

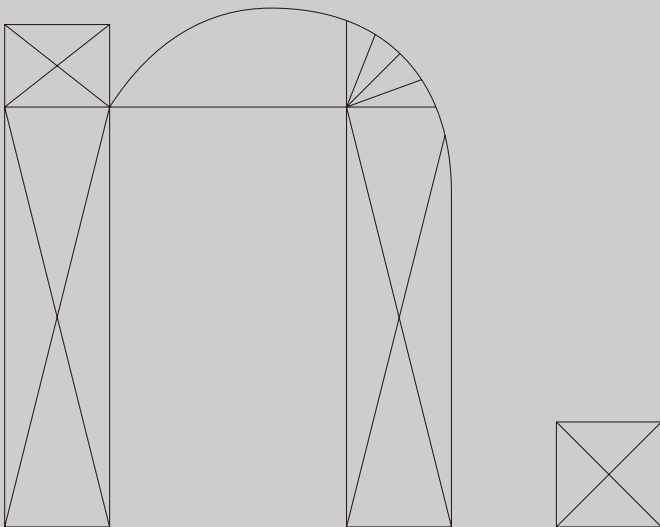

# Notice board

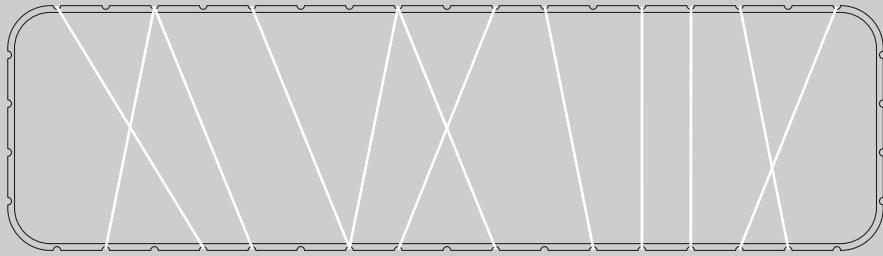

can be organized with stretchable cords

## Colours

### Notice board frame



graphite

grey

white

### Stretchable cords



graphite

grey

white

brilliant yellow

fuchsia

lipstick red

niagara green

### Cover fabric

Selectable according to fabric collection, see pages 14/15

## Sizes

Height: 50cm

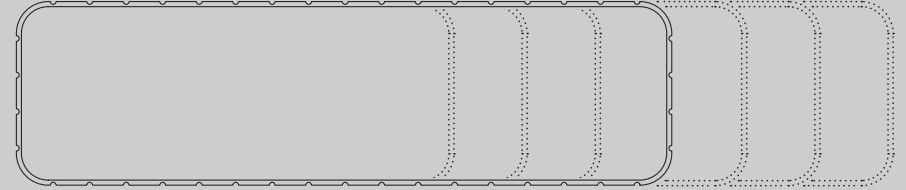

Height: 60cm

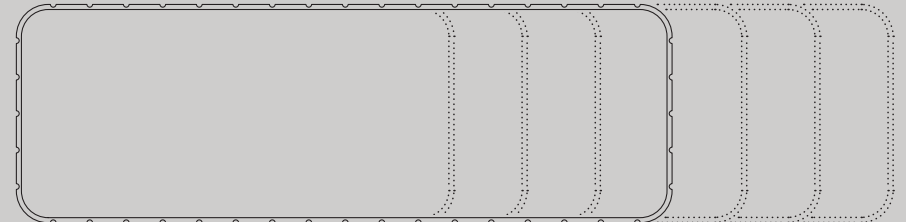

Available lengths in cm

120 140 160 180 200 220 240

## Materials

<b>Notice board frame</b>	Steel frame, matt powder coated
<b>Notice board element</b>	Melamine resin coated chipboard and softboard with fabric covering by Kvadrat or Camira
<b>Stretchable cords</b>	Braided rubber cord Ø 5mm with core made of natural rubber threads, polyester braiding in the covering and visible natural rubber threads on the outside

### Important

When fully stretched, the cords will be under high tension, which, when suddenly released, can cause serious injuries. Therefore, please make sure that you only stretch the cords on a slant over a maximum of 4 notches on the notice board, in order not to exceed the permissible stress/strain ratio.

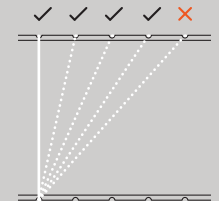

# Desk

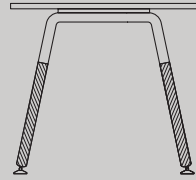
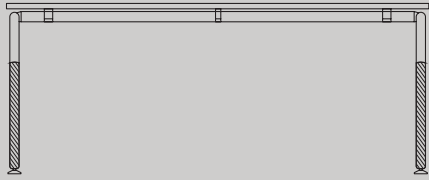

Frame with solid wood elements

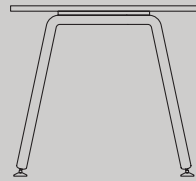

Frame entirely of metal

**Lengths in cm:**

120 / 140 / 160 / 180 / 200 / 220 / 240

**Widths in cm:**

60 / 80 / 90 / 100

**Height in cm:**

74

# Conference table

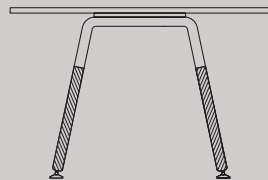
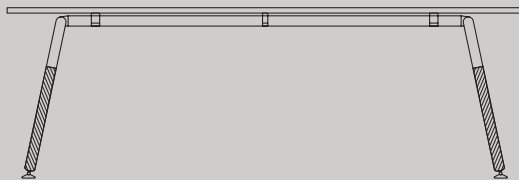

Frame with solid wood elements

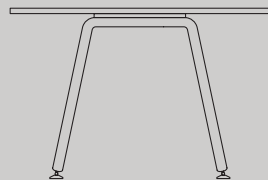

Frame entirely of metal

**Lengths in cm:**

120 / 140 / 160 / 180 / 200 / 220 / 240

**Widths in cm:**

60 / 80 / 90 / 100 / 120

**Height in cm:**

74

## Colours

**Tabletop / Frame**



graphite



grey



white

**Solid wood elements for the frame**



oak



walnut

## Materials

<b>Table top</b>	Melamine resin coated, edged quality chipboard, 25 mm thick
<b>Frame / round steel tubing</b>	Ø 40mm, matt powder coated
<b>Wood elements (frame)</b>	solid oak or walnut, matt varnished

## Features

**Table top** available either with rounded corners (radius 80 mm) or with rectangular corners.

**Optimum cable management** through cable duct in combination with sliding plate or fixed plate with cable outlets.

**MyMotion table frame** optionally available with solid wood elements or entirely of metal, and adjustable by means of 25 mm level adjustment.

Since **wood** is a natural material, it is subject to variations in color and/or grain.

**Alternative design:** Table frame Motion AD A-foot design with telescopic height adjustment from 640-820 mm, without wood elements.

## Sliding-door cabinet



W: 100 / 120 / 160cm



W: 100 / 120 / 160cm



W: 100 / 120 / 160cm



W: 100 / 120 / 160cm



W: 100 / 120cm

## Hinged-door cabinet



W: 100cm



W: 100cm



W: 100cm



W: 100cm



W: 100cm

D: 45,4cm  
H: 55cm = 1,5FH

D: 45,4cm  
H: 75cm = 2FH

D: 45,4cm  
H: 112,5cm = 3FH

D: 45,4cm  
H: 150cm = 4FH

D: 45,4cm  
H: 187,5cm = 5FH

## Colours

### Body



graphite



grey



white

### Front / Display set



graphite



grey



white



brilliant yellow



fuchsia



lipstick red



niagara green

### Front



oak



walnut

## Materials

### Body and fronts

Melamine resin coated, edged, quality chipboard

### Displayset

- Braided rubber cord Ø 5 mm with core made of natural rubber threads, polyester braiding in the covering and visible natural rubber threads on the outside
- Powder-coated aluminum U-profile, 20 mm deep

## Features

The following **cabinet designs** are available:

- Standing cabinet with various base options
- Top-mounted cabinet
- Wall cabinet with visible mounting strips (up to max. 3x file height = 3FH, for mounting directly on walls)

Sliding-door cabinets with **center divider**, hinged-door cabinets available with or without center divider.

All cabinets are equipped with **shelves** that can be height-adjusted in 25 mm increments.

Doors with display sets have **no additional handle element**.

Doors without display sets are equipped with a powder-coated **metal strip handle**.

Standard built-in **cylinder pressure lock** for sliding-door cabinets, **espagnolette lock** for hinged-door cabinets

# Rollcontainer

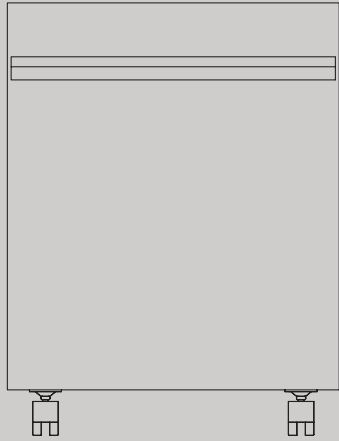

Front view

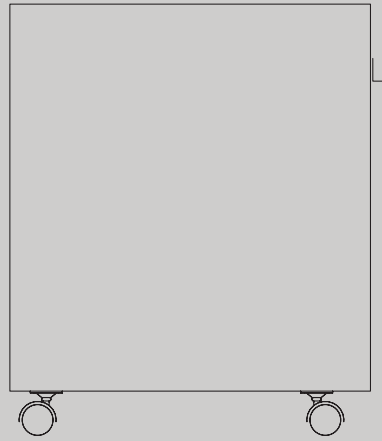

Side view

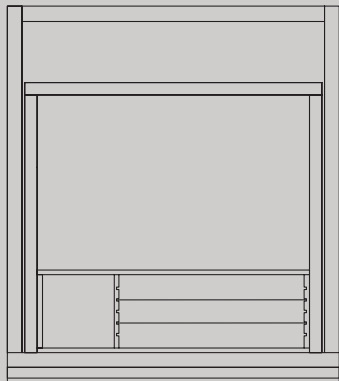

Top view of interior

W: 43,2cm  
D: 49cm  
H: 56cm

## Colours

### Body



graphite

grey

white

### Front / Handle



graphite

grey

white

brilliant yellow

fuchsia

lipstick red

niagara green

### Front

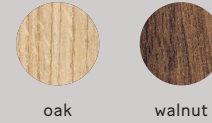

oak

walnut

## Materials

<b>Body and Fronts</b>	Melamine resin coated, edged quality chipboard, 19 mm thick
<b>Handle</b>	Powder-coated aluminum U-profile, 20 mm deep
<b>Utensil drawer</b>	Plastic, inside; with melamine resin coated chipboard front, 16 mm thick
<b>Wood elements (frame)</b>	solid oak or walnut, matt varnished
<b>Flip drawer</b>	<ul style="list-style-type: none"> <li>• Side walls: melamine coated, edged, quality chipboard, 16 mm thick; soft-closing mechanism</li> <li>• Interior: 6 mm birch plywood, glued and varnished; 1 mm steel compartments, powder coated</li> </ul>
<b>Wheels</b>	Plastic, lockable

## Features

**Anti-tipping protection** thanks to integrated counterweight.  
Standard built-in **cylinder lock**.  
Rolling file cabinet optionally available with **seat cushion**.

## Toolbox

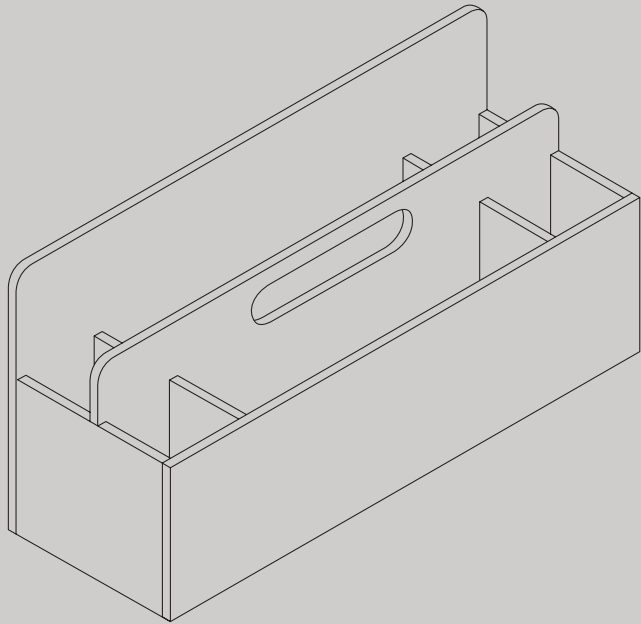

W: 35,1cm  
D: 12cm  
H: 17cm

### Colours

#### Body



graphite

#### Handle



graphite



brilliant yellow



fuchsia



lipstick red



niagara green

### Materials

6mm birch plywood, glued and varnished

## Seat cushion

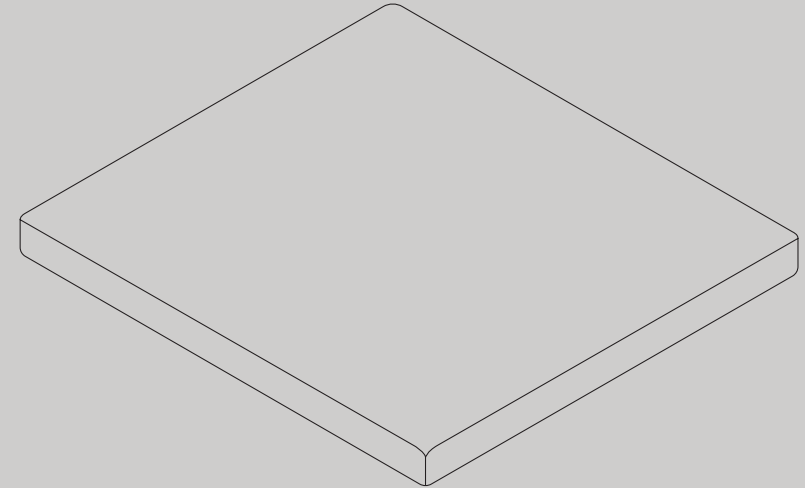

W: 43,2cm  
D: 47cm  
H: 3,2cm

### Colours

#### Cover fabric

Selectable according to fabric collection, see pages 14/15

### Materials

MDF board, foam, nonwoven padding, fabric cover

# Coatrack

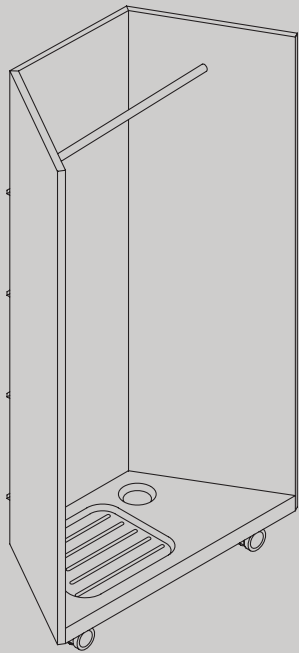

Trapezoidal W: 102,4cm  
D: 50,7cm  
H: 185cm

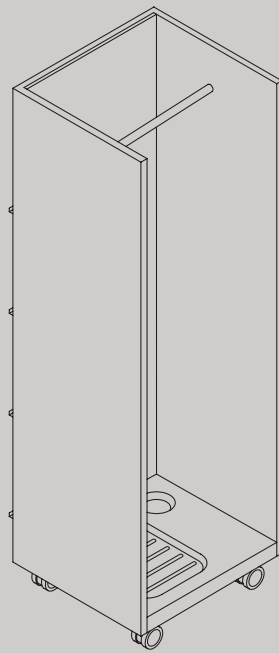

Rectangular W: 60,3cm  
D: 56,8cm  
H: 185cm

Trapezoidal coatrack with or **without hat shelf** (see illustration).  
Rectangular coatrack available only without hat shelf.

## Care instructions

The concrete base has a dirt-repellent finish. Nevertheless, we recommend that you keep your wardrobe as clean and dry as possible and remove any dirt residue as soon as possible with a mild detergent. Please note that the concrete base will show signs of wear over time.

## Colours

### Body



### Front / Handle



### Front



## Materials

<b>Body and fronts</b>	Melamine resin coated, edged, quality chipboard
<b>Display set</b>	<ul style="list-style-type: none"> <li>Braided rubber cord Ø 5 mm with core made of natural rubber threads, polyester braiding in the covering and visible natural rubber threads on the outside</li> <li>Powder-coated aluminum U-profile, 20 mm deep</li> </ul>
<b>Whiteboard</b>	1mm laminate, optionally magnetic
<b>Mirror</b>	3 mm mirror glass glued onto carrier board
<b>Concrete base</b>	50 mm thick, dirt-repellent finish
<b>Wheels</b>	Plastic, lockable

**Important**  
Never let children play in or climb on the coatrack. Do not store heavy objects on the hat shelf.  
The integrated concrete base only provides anti-tipping protection under normal use. Weight of the coatrack: approx. 90 kg

# Fabric collection

## Camira – Citadel



FL830 Resistance    FL825 Lookout    FL821 Fortress    FL823 Manor    FL822 Beacon    FL832 Redoubt    FL833 Confine

## Camira – Xtreme

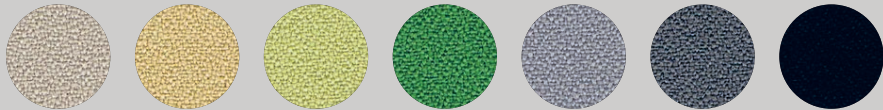

YS108 Aruba    YS166 Manado    YS096 Apple    YS159 Lombok    YS094 Slip    YS081 Blizzard    YS009 Havana

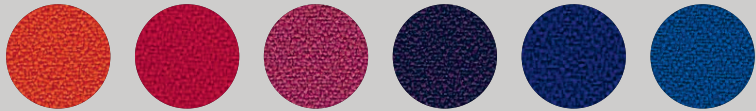

YS076 Lobster    YS079 Panama    YS101 Diablo    YS084 Tarot    YS100 Ocean    YS082 Scuba

## Camira – Sonus

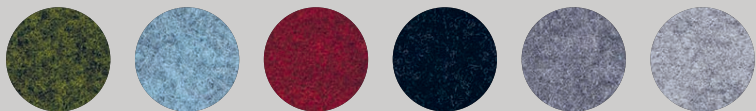

FHU08 Vocal    FHR06 Audio    FHU10 Chime    FHR05 Amp    FHU04 Music    FHR03 Beat

## Camira – Patina



PAT19 Rippled    PAT18 Blurred    PAT14 Covered    PAT40 Striated    PAT32 Anodised    PAT05 Reclaimed    PAT25 Glisten



PAT03 Seasoned

## Kvadrat – Remix 2

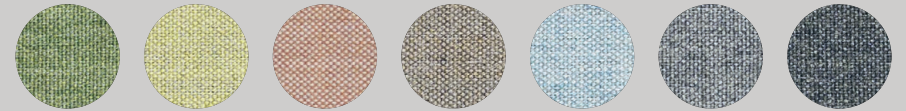

RE933    RE923    RE612    RE233    RE823    RE133    RE163

## Kvadrat – Tonica 2

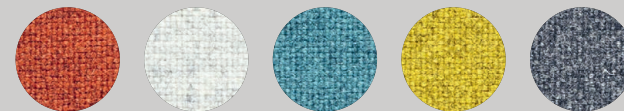

TO531    TO111    TO831    TO411    TO132



**neudoerfler**  
For people with drive.